



Marc Kratzschmar

Implementing the Canadian National Road Network linear referencing data model at New Brunswick DOT

Acknowledgements

- **New Brunswick DOT Project Team**
 - Kim Mathisen
 - Dawn Vincent Dixon
 - Pablo Romero
 - Dean Fletcher
- **Exor Project Team**
 - Zubran Solaiman
 - Sarah Kistulinec
 - Jon Libby

Three Stories

National Road Network

New Brunswick DOT Project

Network Data Lessons

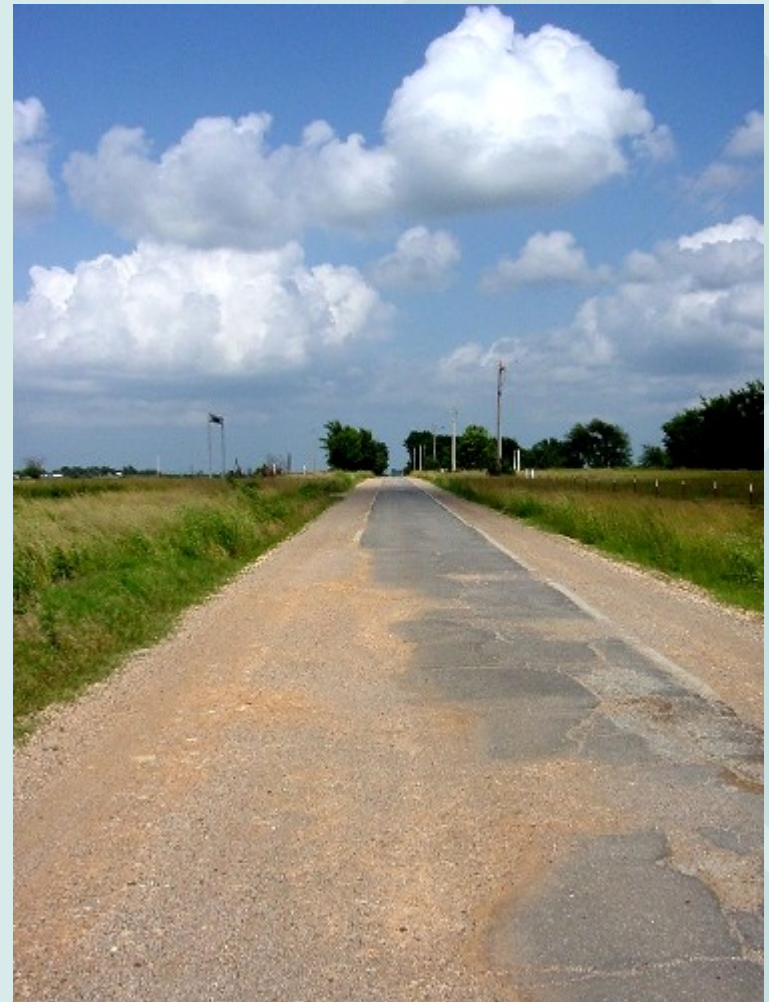

Not much time, but they're all related

Canadian National Road Network (NRN)

*National Street Data Model
National Street Database*

*National Partnership
Led by NRCan*

*Objective: One homogeneous
(core) geometry for the entire
Canadian Landmass and
maintained by closest to the
source providers.*



Canadian National Road Network (NRN)

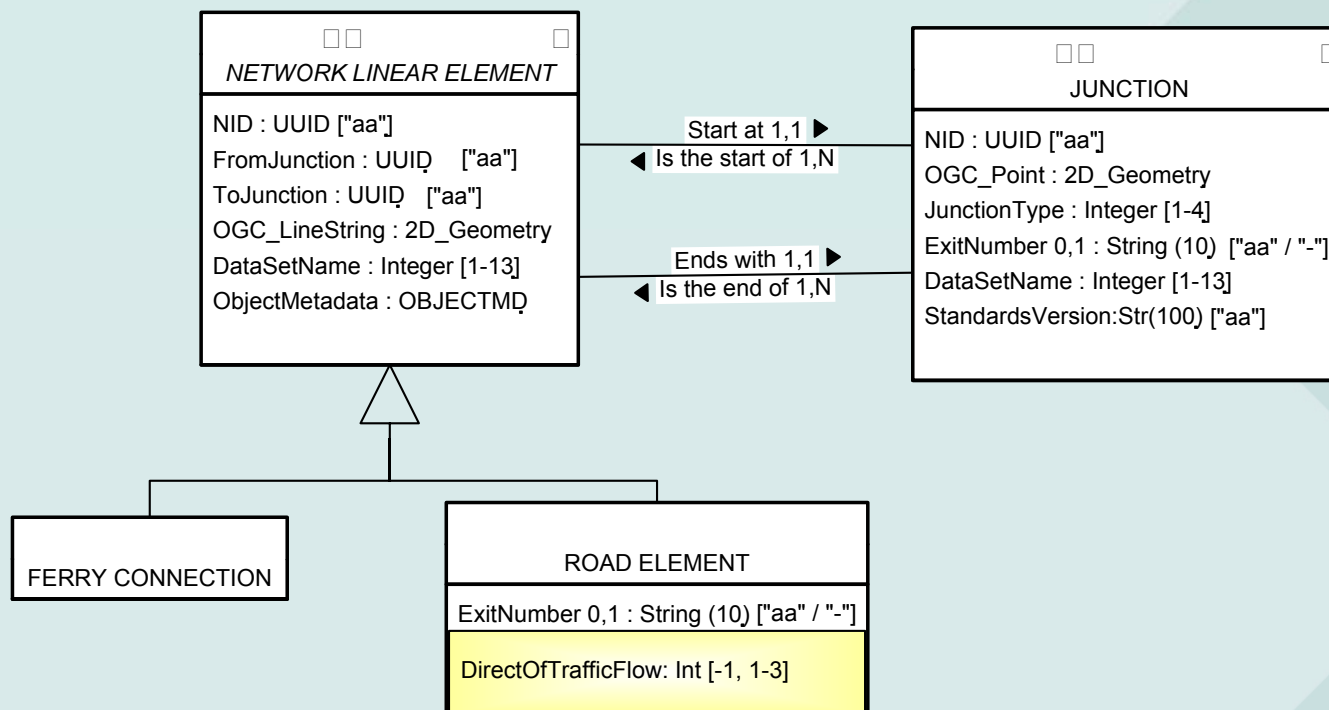

Canadian National Road Atlas (NRN)

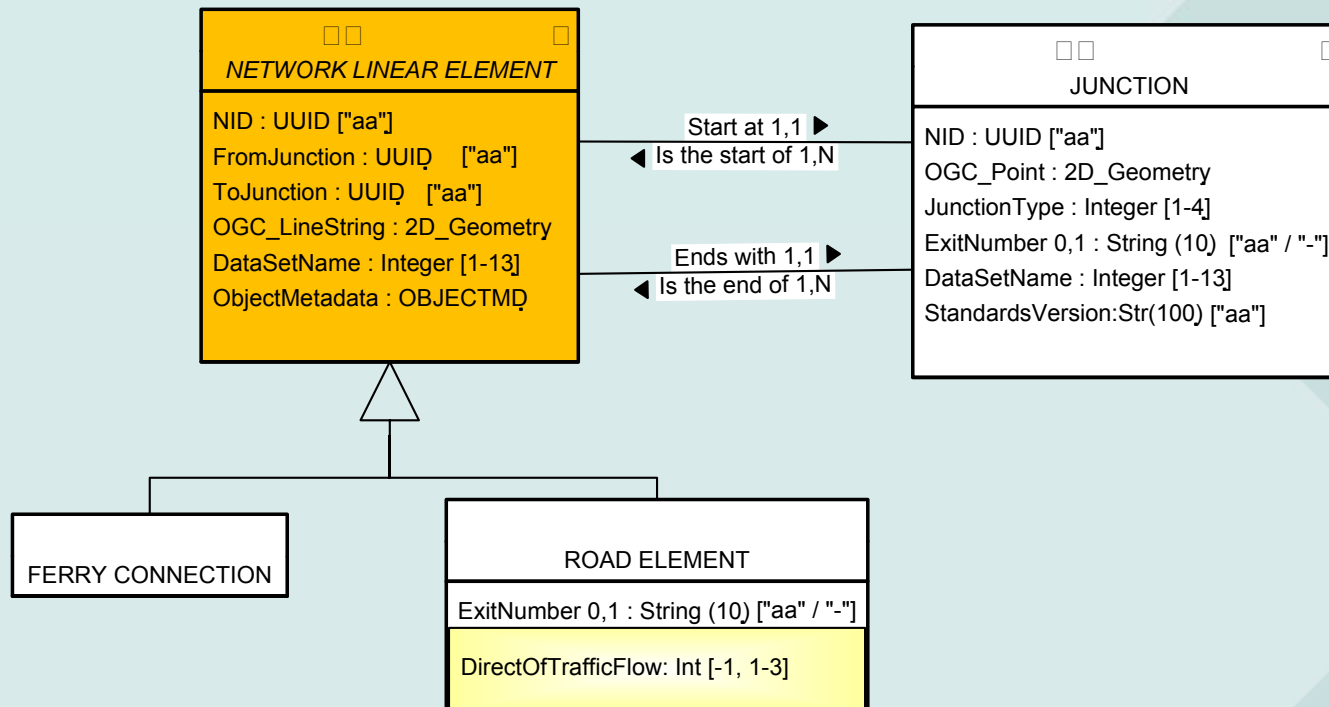

Canadian National Road Network (NRN)

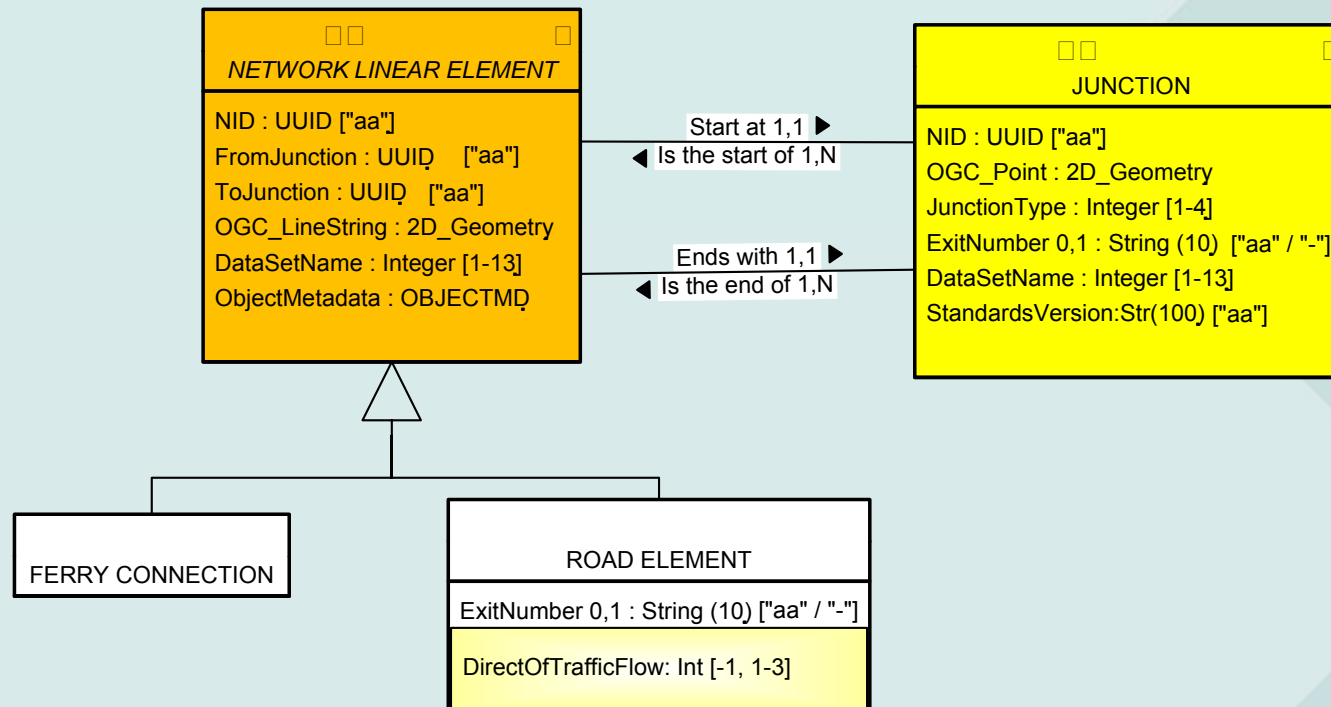

Canadian National Road Network (NRN)

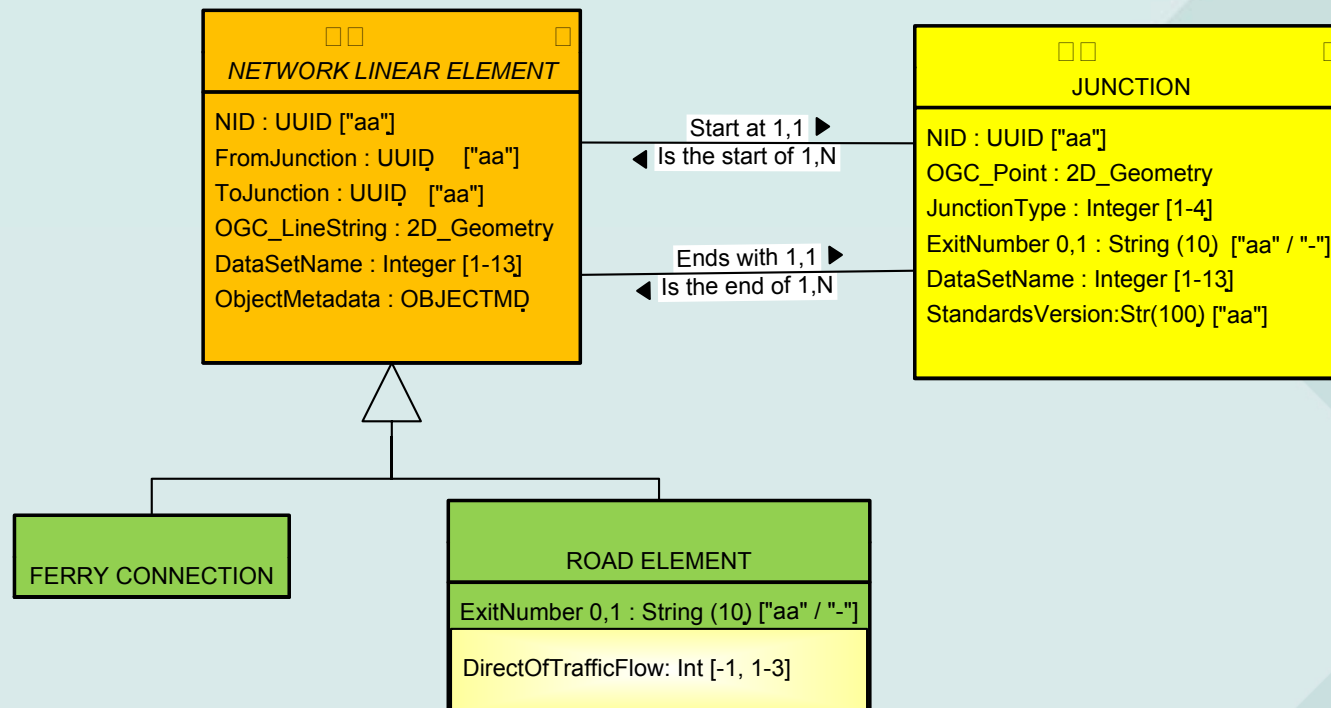

Canadian National Road Network (NRN)

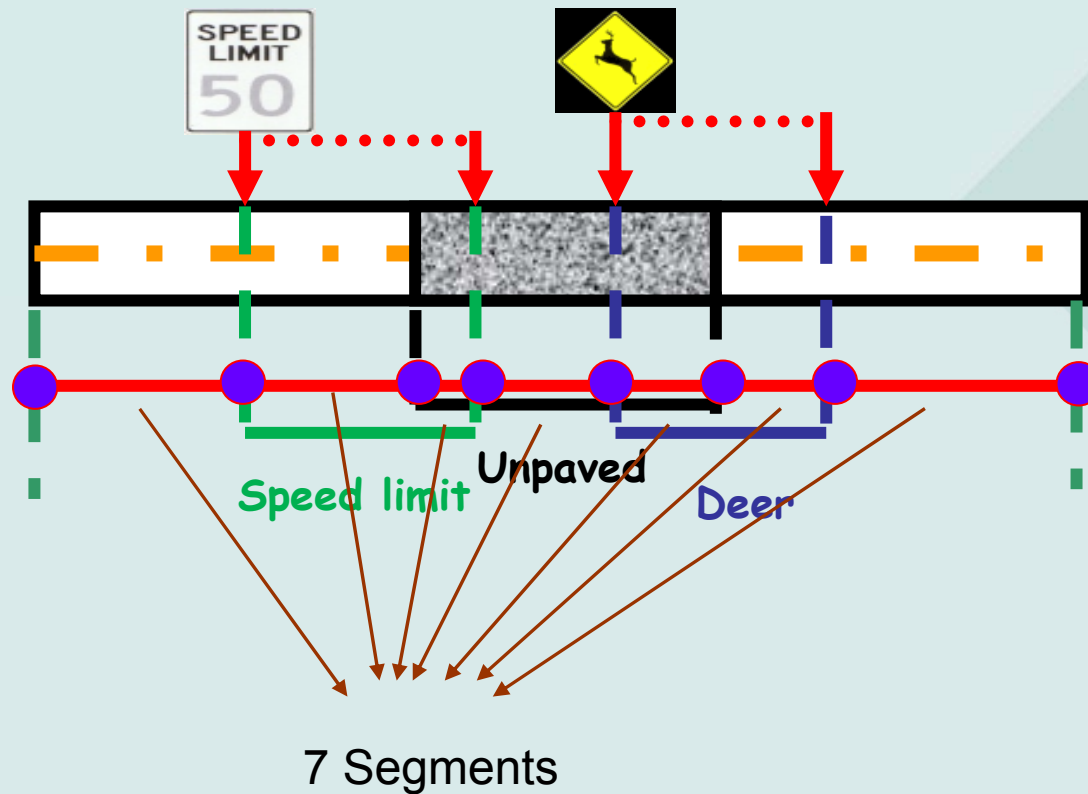

Thanks to Marcel Sabourin

Segmented View



NBDOT TRAMS Implementation

Transportation Related Attribute Management System (TRAMS)



NBDOT TRAMS Implementation Objectives

Implement Provincial Version of National Road Network (NBRN)

Municipal

More Attributes or Geometry

Provincial

More Attributes or Geometry

National

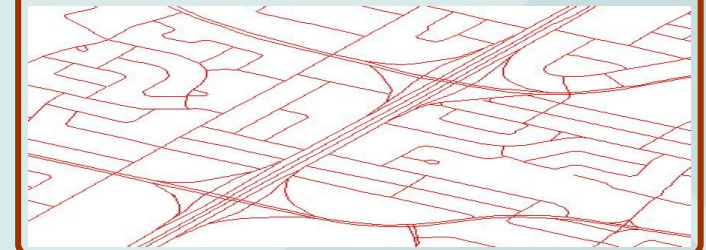

NBDOT TRAMS Implementation Objectives

Implement Provincial Version of National Road Network (NBRN)

- **Topological Differences**
 - Junctions at County Boundaries
- **Different Event Model**
 - Roads as traversals, not events
- **Convenient Denormalization**
 - Control Section IDs on CSNM events

More Attributes or Geometry

More Attributes or Geometry

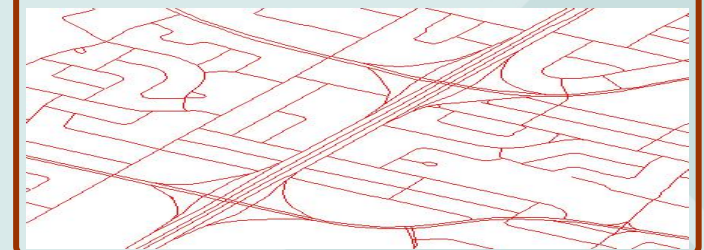

NBDOT TRAMS Implementation Objectives

Implement Provincial Version of National Road Network (NBRN)

Replace Legacy Systems

Transportation Network Management System (TNMS)

Highway Digital Map (HDM)

- **GIS street centerline**
- **Caris to ArcGIS migration**

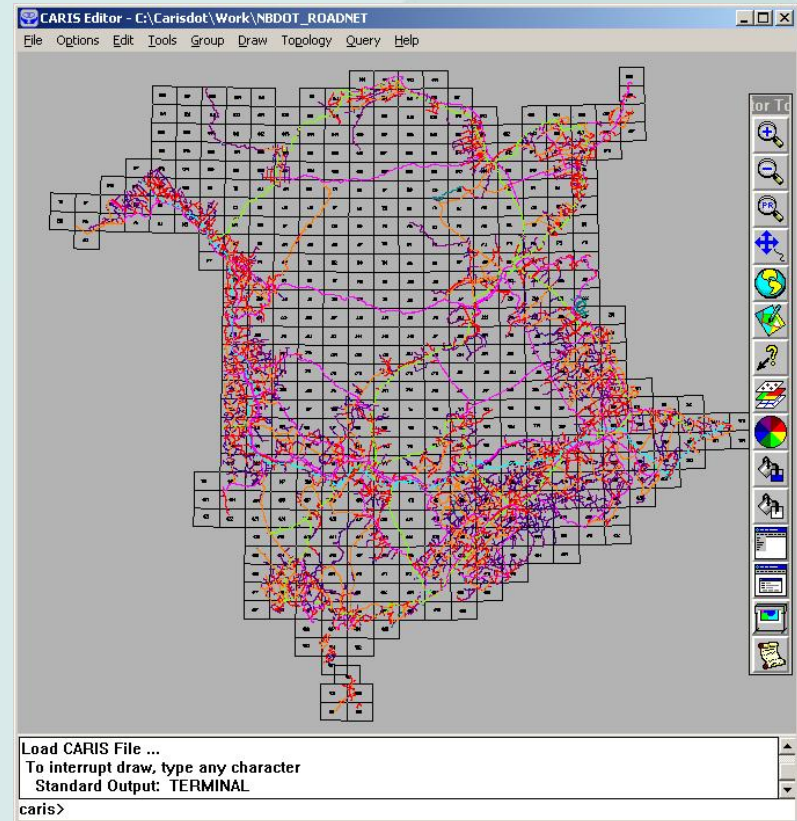

NBDOT TRAMS Implementation Objectives

Implement Provincial Version of National Road Network (NBRN)

Replace Legacy Systems

Integrate Spatial and Logical Data

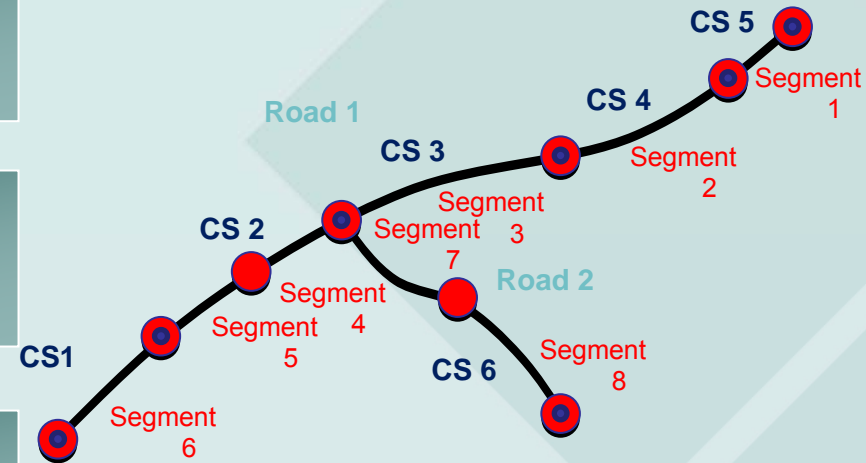

Anchor Sections and Control Sections from HDM

NBDOT TRAMS Implementation Objectives

Implement Provincial Version of National Road Network (NBRN)

Replace Legacy Systems

Integrate Spatial and Logical Data

Control Sections

CS ID	Length
1	3
2	2
3	4
4	2
5	3
6	5

Roads

Road	Name
1	Rt 2
2	Maple St

Events

Asset	CS	Start	End
Bridge 4	1	1km	2km
Sign 5	2	4.5km	

Anchor Sections and Control Sections from HDM
Control Sections and Roads and Events from TNMS

NBDOT TRAMS Implementation Solution

Implement Provincial Version of National Road Network (NBRN)

Replace Legacy Systems

Integrate Spatial and Logical Data

Exor suite of network data management software

- **Network Manager , Spatial Server, Asset Manager, Spatial Manager**

Reorganization to combine maintenance teams

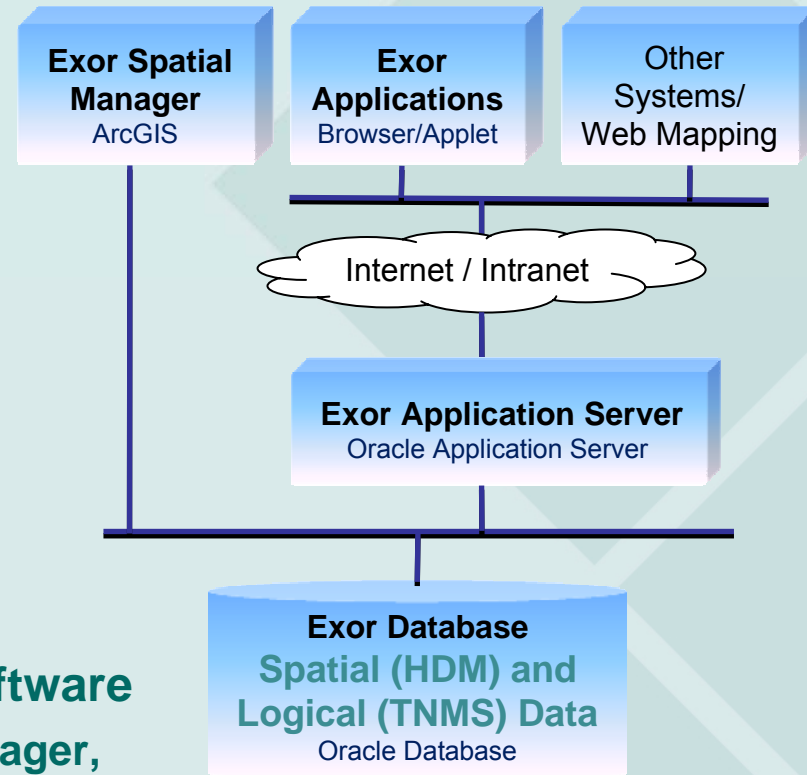

NBDOT TRAMS Implementation Project

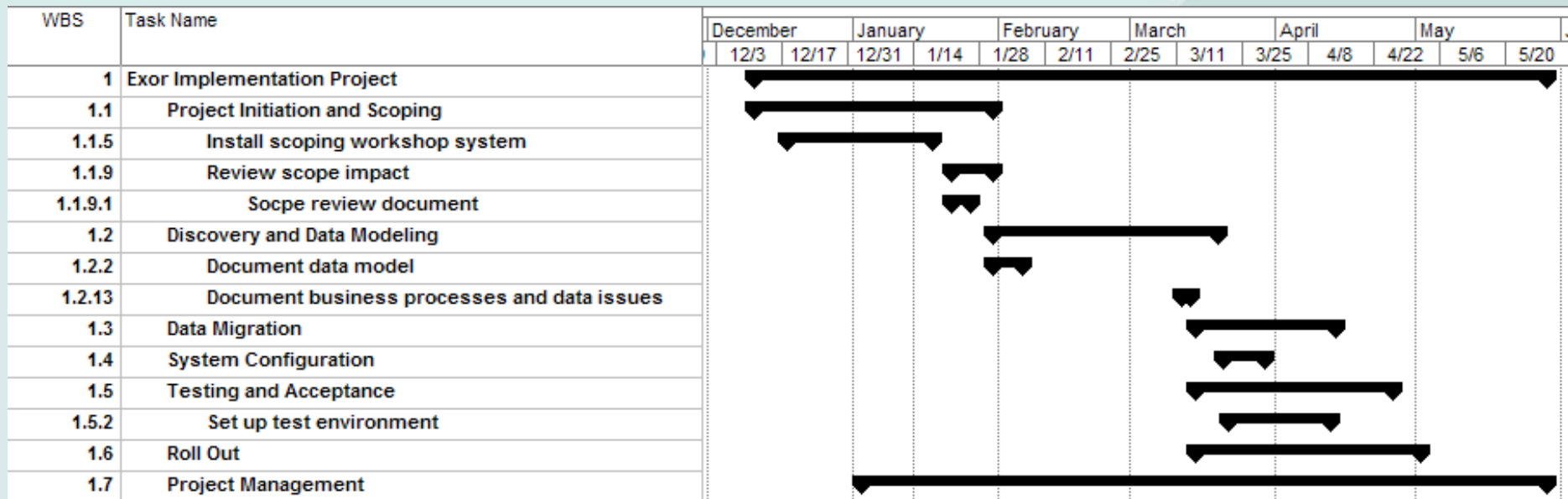

Small Project

NBDOT TRAMS Implementation Project

WBS	Task Name	December		January		February		March		April		May			
		12/3	12/17	12/31	1/14	1/28	2/11	2/25	3/11	3/25	4/8	4/22	5/6	5/20	
1	Exor Implementation Project	[Gantt bar from 12/3 to 5/20]													
1.1	Project Initiation and Scoping	[Gantt bar from 12/3 to 1/28]													
1.1.5	Install scoping workshop system	[Gantt bar from 12/17 to 1/14]													
1.1.9	Review scope impact	[Gantt bar from 1/14 to 1/28]													
1.1.9.1	Scope review document	[Gantt bar from 1/14 to 1/28]													
1.2	Discovery and Data Modeling	[Gantt bar from 1/28 to 3/11]													
1.2.2	Document data model	[Gantt bar from 1/28 to 2/11]													
1.2.13	Document business processes and data issues	[Gantt bar from 2/11 to 2/25]													
1.4	System Configuration	[Gantt bar from 3/11 to 3/25]													
1.5	Testing and Acceptance	[Gantt bar from 3/11 to 4/8]													
1.5.2	Set up test environment	[Gantt bar from 3/11 to 3/25]													
1.6	Roll Out	[Gantt bar from 3/11 to 4/22]													
1.7	Project Management	[Gantt bar from 1/28 to 5/20]													

Big Mistake

Network Restructuring

Before Restructuring

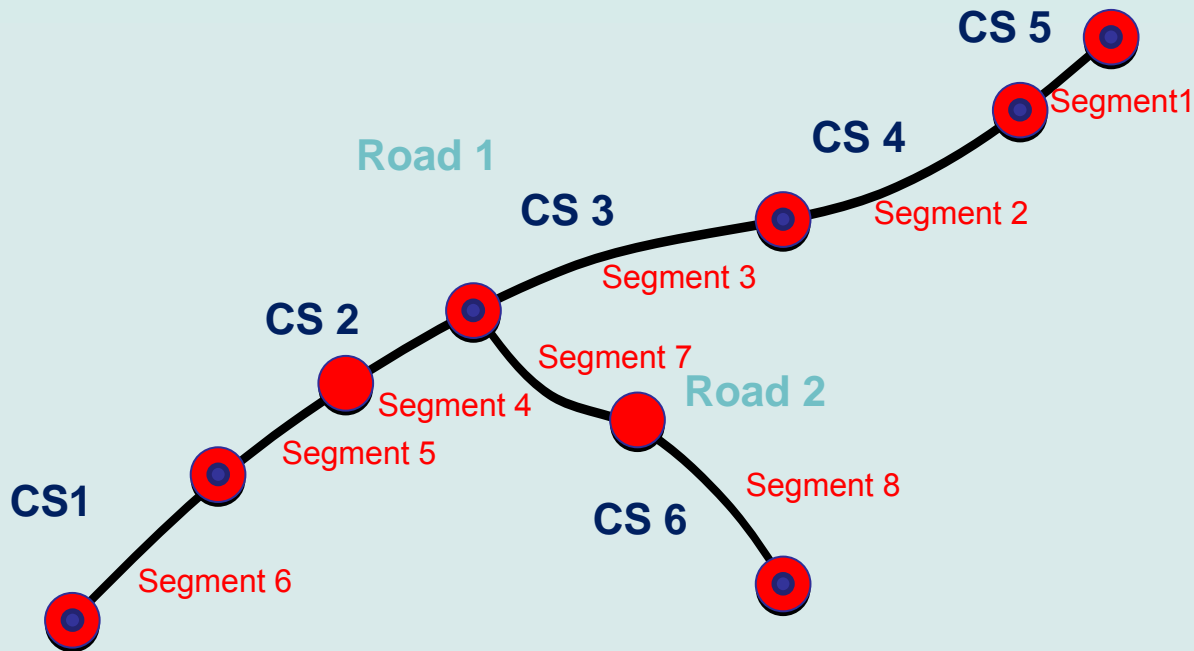

Network Restructuring

After Restructuring

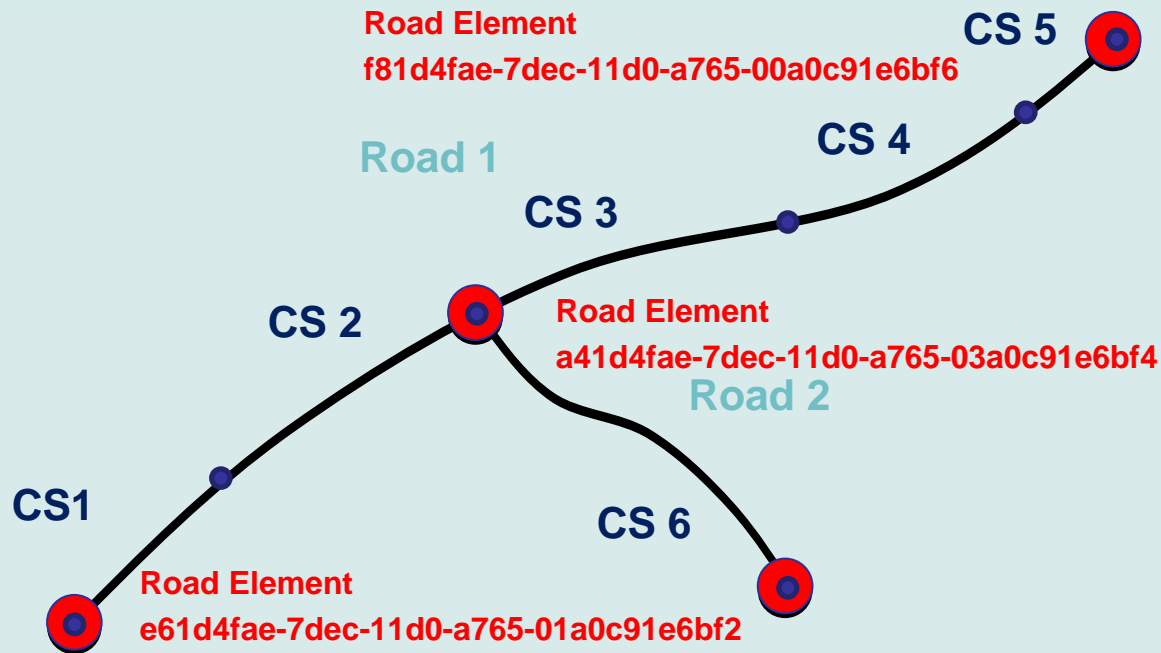

Network Restructuring

Precision Issues

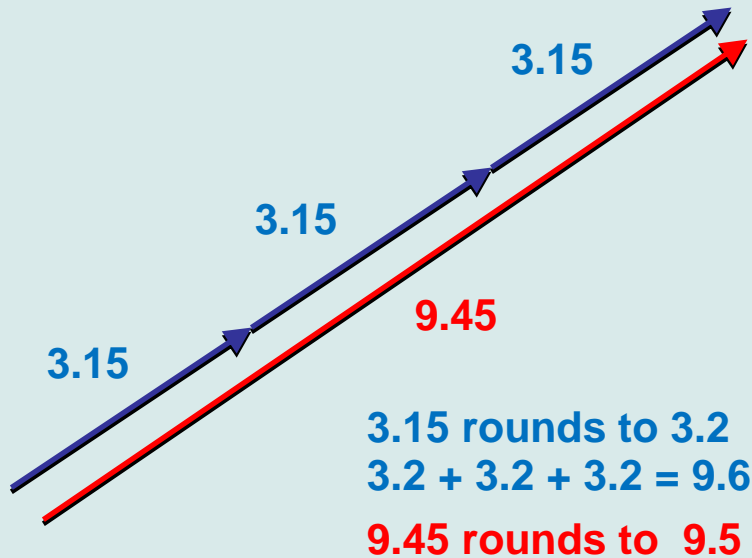

Adding rounded numbers introduces inaccuracy

Network Restructuring

Cardinality Issues

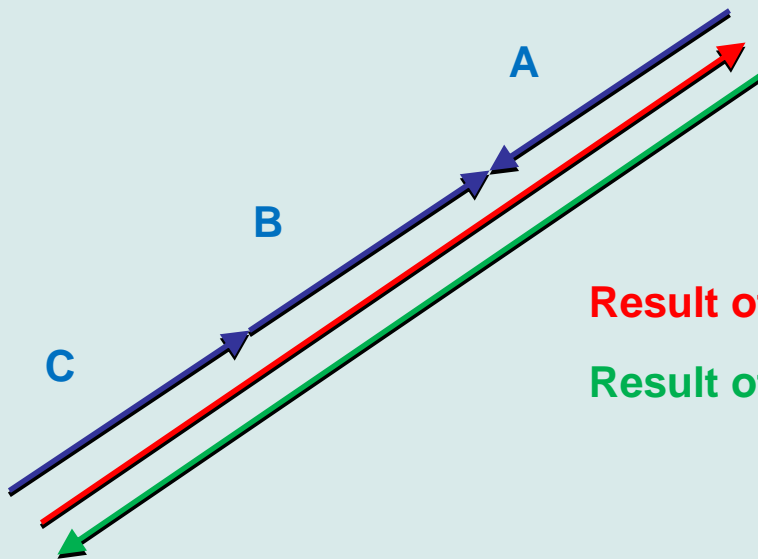

Result of merging B to C then A to CB

Result of merging B to A then C to AB

Network Restructuring

Lessons

- Network data can be restructured
- Think it through first
 - Sequence is everything
- Plan to test
- Plan to rework



Thank you for your time. Any questions?

*Marc Kratzschmar
Exor Corporation
mkratzschmar@exorcorp.com
+1 (619) 521 2594*